

USER'S GUIDE

EE160 - Humidity and Temperature Transmitter for HVAC Applications

GENERAL

The EE160 transmitter, available for wall or duct mounting, is designed for the measurement of humidity and temperature in HVAC applications. The transmitter incorporates the E+E humidity and temperature sensor HCT01.

For use in special applications do not hesitate to contact E+E Elektronik or a local distributor.

CAUTION

- For accurate measurement it is essential that the temperature of the sensing probe and mainly of the sensing head is same as the temperature of the air to measure. Avoid mounting the EE160 transmitter in a way which creates temperature gradients along the probe.
- The transmitter and mainly the sensing head shall not be exposed to extreme mechanical stress.
- The transmitter must be operated with the filter cap on at all times. Do not touch the sensors inside the sensing head.
- While replacing the filter cap (because of pollution for instance) against an original E+E spare one please take very good care to not touch the sensors.

DIMENSIONS

Type A

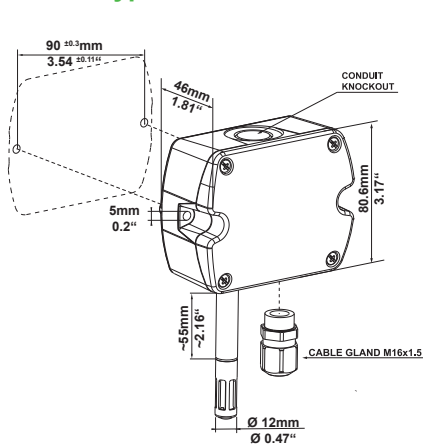

Type B

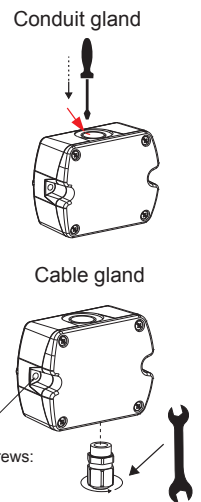
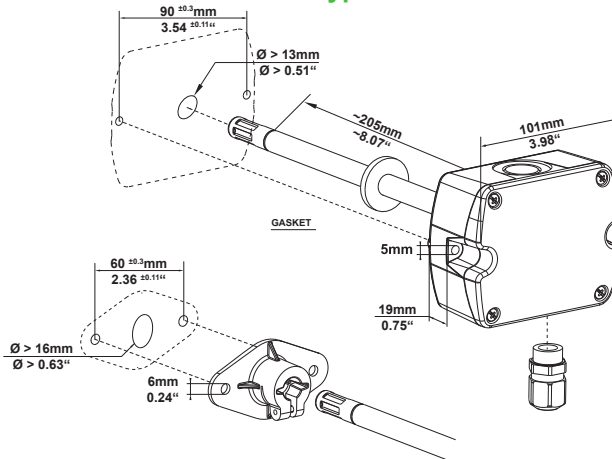

EE160 with cable gland: Use a matching wrench to install the cable gland (in the scope of supply) onto the EE210 enclosure.

CONNECTION DIAGRAM

EE160-HT3xxx

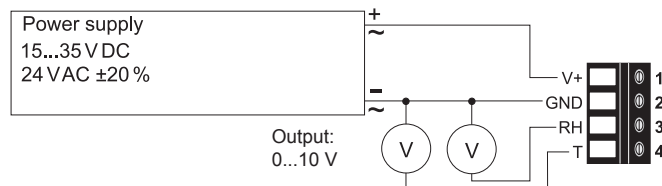
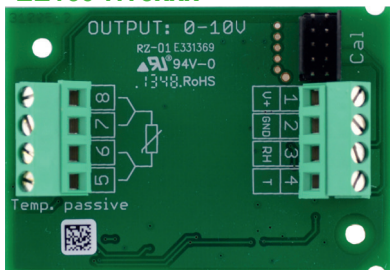

T-passive connection for HT3xxx/HT6xxx

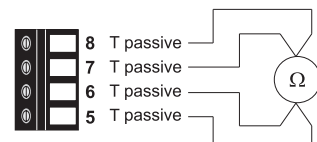

EE160-HT6xxx

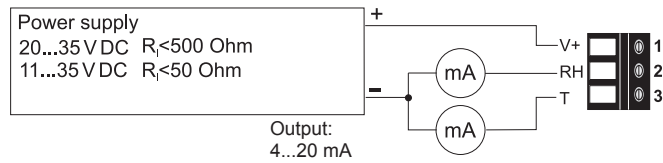
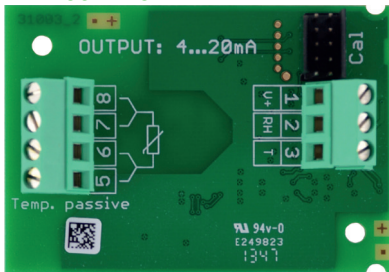

EE160-HTx3xx

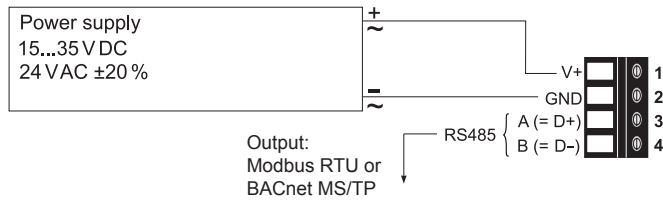
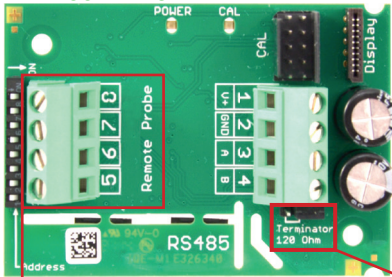

Bus termination resistor 120 Ω (jumper)

DO NOT CONNECT!

LED INDICATION

Green LED - information to normal operation mode:

- on = everything OK
- flashing = the main board does not recognize the measurement electronics inside the sensing probe
- off = no power supply or main board failure

Blue LED - information during setup with the optional E+E Configuration Kit:

- on = E+E Product Configuration Adapter (EE-PCA) is powered, no communication in progress
- flashing = EE-PCA powered, communication in progress
- off = EE-PCA not connected to the EE160

SCOPE OF SUPPLY

Model	EE160 Wall mount (Type A)	EE160 Duct mount (Type B)	Additionally for all EE160 with RS485 interface
EE160 Transmitter according ordering guide	✓	✓	
Cable gland	✓	✓	✓
Mounting kit	✓	✓	
Mounting flange		✓	
Inspection certificate according to DIN EN10204 - 3.1	✓	✓	
Quick Guide - EE160 RS485 Setup			✓

DIGITAL SETTINGS

Address Setting

Address Switch

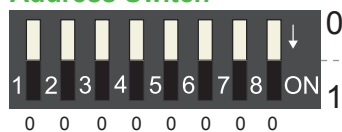

Slave address setting via EE-PCS Product Configuration Software:

All Dip-Switches at position 0 → address has to be set via configuration software (factory setting: Modbus...245 / BACnet...2).

Example: Slave address is set via configuration software.

Address Switch

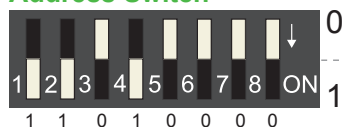

Slave address setting via Dip-Switch:

Setting the Dip-Switch to any other address than 0 overwrites the slave address set via configuration software.

Example: Slave address set to 11 (=00001011 binary).

BACnet Setup

BACnet PICS are available for download at www.epluse.com/EE160

Modbus Setup

The measured values are saved as a 32Bit float value from 0x19 to 0x1B. Additionally, the measured values can be read as 16-bit signed integer from 0x12C to 0x12D.

The factory setting for the Slave-ID is 245 as an integer 16Bit value. This ID can be customised in the register 60001 (0x00) (value margin 1 - 247 permitted).

The required units (metric or non-metric) must be selected in the „Ordering guide“, see EE160 data sheet.

FLOAT (read register):		
Register address	Communication address	Parameter name
30026	0x19	Temperature [°C], [°F]
30028	0x1B	relative Humidity [%]

INFO (read register):		
Register address	Communication address	Parameter name
30001	0x00	Serial number (as ASCII)
30009	0x08	Firmware version

INTEGER (read register):*		
Register address	Communication address	Parameter name
30301	0x12C	Temperature [°C], [°F]
30302	0x12D	relative Humidity [%]

INTEGER (write register):*		
Register address	Communication address	Parameter name
60001	0x00	Slave-ID (modbus adresse)
60002	0x01	Modbus protocol settings*

* Values are stored with a scaling of 1:100
(e.g.: 2550 is equivalent to 25.5°C)

* For Modbus protocol setting please see
Application Note Modbus (www.epluse.com/EE160)

Protocol setting:

Address, baudrate, parity and stop bits can be set via:

1. Configurator software (available on www.epluse.com/EE160)
2. Modbus protocol (please see Application Note Modbus available on www.epluse.com/EE160)

TECHNICAL DATA

Measured values

Relative Humidity

Sensor	E+E Sensor HCT01-00D
Working range	10...95 % RH
Accuracy at 20°C	±2.5 % RH
Temperature dependency	typ. ±0.03 % RH/°C

Temperature

Sensor	Pt1000 (tolerance class B, DIN EN 60751)
T-Accuracy at 20°C	±0.3 °C

Outputs

Analogue output (RH: 0...100%; T: see ordering guide)	0-10 V 4-20 mA (two-wire)	-1 mA < I _L < 1 mA or R _L < 500 Ohm
Digital output	RS485 (BACnet MS/TP or Modbus RTU) max. 32 EE160 in one bus	
Passive T-sensor 4-wire	see ordering guide	

General

Power supply (Class III) 	for 0 - 10 V / RS485 for 4 - 20 mA	15 - 35V DC or 24V AC ±20 % 10V + R _L x 20 mA < U _v < 35V DC
Current consumption	Analogue	with DC power supplytyp. 5 mA with AC power supplytyp. 13 mA _{eff}
	Digital	with DC power supplytyp. 15 mA with AC power supplytyp. 25 mA _{eff}
Connection	Screw terminals, max. 1.5 mm ²	
Housing material	Polycarbonate, UL94V-0 approved	
Protection class	IP65 / NEMA 4	
Cable gland	M16 x 1.5	
Sensor protection	membrane filter	
Electromagnetic compatibility	EN61326-1 EN61326-2-3	
Temperature ranges	Operating temperature: -40...60 °C (-40...140 °F) Storage temperature: -20...60 °C (-4...140 °F)	

SETUP AND ADJUSTMENT

The EE160 transmitter is ready to use and does not require any configuration by the user. The factory setup of EE160 corresponds to the type number ordered. For ordering guide please see data sheet at www.epluse.com/EE160.)

If need, the user can change the factory setup by using the optional E+E Product Configuration Adapter (EE-PCA) and the E+E Product Configuration Software (EE-PCS).

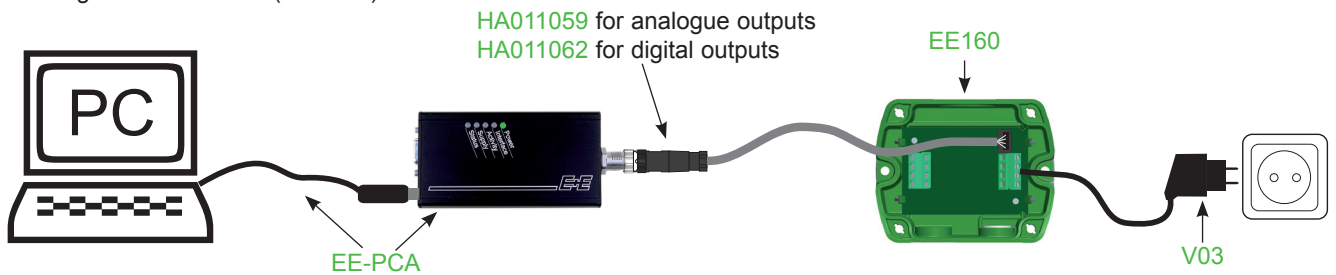

One can assign other physical quantities to the analogue outputs, change the scaling of the outputs and perform one or two point adjustment for humidity and temperature.

For product data sheets EE-PCS and EE-PCA please see www.epluse.com.

The E+E Product Configuration Software (EE-PCS) is free and can be downloaded from www.epluse.com/configurator.

MAINTENANCE

Calibration and adjustment:

Depending on the application and the requirements of certain industries, there might arise the need for periodical humidity calibration (comparison with a reference) or adjustment (bringing the device in line with a reference).

- Calibration and adjustment at E+E Elektronik
Calibration and/or adjustment can be performed in the E+E Elektronik calibration laboratory. For information on the E+E capabilities in ISO or accredited calibration please see www.eplusecal.com.
- Calibration and adjustment by the user
Depending on the level of accuracy required, the humidity reference can be:
 - Humor 20 Humidity Calibrator, please see www.epluse.com.
 - Omniport30 handheld device, please see www.epluse.com/omniport30.
 - Calibrated salt solutions, please see www.epluse.com/EE160.

Cleaning of the sensing head:

Use in polluted environment might rise the need for cleaning the sensing head and replacing the filter cap. In such a case please see "Cleaning Instructions" at www.epluse.com/EE160.

When employed in dusty, polluted environment:

- The filter cap shall be replaced once in a while with an E+E original one. A polluted filter cap causes longer response time of the device.
- If needed, the sensing head can be cleaned. For cleaning instructions please see www.epluse.com/EE160.

ACCESSORIES

Configuration kit: The configuration kit allows user setup for the output scaling and for the interface parameters, as well as humidity and temperature adjustment of the sensor.

Position 1:

- configuration adapter (incl. USB cable for PC) EE-PCA

Position 2:

- for analogue outputs: cable for configuration adapter HA011059
- for digital outputs: cable for configuration adapter HA011062

Position 3:

- configuration software: free of charge; download: www.epluse.com/EE160

Position 4 - optional:

- power supply for EE160 V03

USA**FCC notice:**

This equipment has been tested and found to comply with the limits for a Class B digital device, pursuant to part 15 of the FCC Rules. These limits are designed to provide reasonable protection against harmful interference in a residential installation. This equipment generates, uses and can radiate radio frequency energy and, if not installed and used in accordance with the installation manual, may cause harmful interference to radio communications. However, there is no guarantee that interference will not occur in a particular installation. If this equipment does cause harmful interference to radio or television reception, which can be determined by turning the equipment off and on, the user is encouraged to try to correct the interference by one or more of the following measures:

- Reorient or relocate the receiving antenna.
- Increase the separation between the equipment and receiver.
- Connect the equipment into an outlet on a circuit different from that to which the receiver is connected.
- Consult the dealer or an experienced radio/TV technician for help.

CANADIAN**ICES-003 Issue 5:**

CAN ICES-3 B / NMB-3 B

INFORMATION**+43 7235 605 0 / info@epluse.com**

Langwiesen 7 • A-4209 Engerwitzdorf
Tel: +43 7235 605-0 • Fax: +43 7235 605-8
info@epluse.com • www.epluse.com

LG Linz Fn 165761 t • UID-Nr. ATU44043101
Place of Jurisdiction: A-4020 Linz • DVR0962759

